

# Gas Go Anywhere<sup>®</sup>

---



# FOR OUTDOOR USE ONLY

This grill does not include an LP fuel tank.

## Check Package Contents

You should have received the parts listed below. While we give much attention to our product, unfortunately an occasional error may occur. If a part is missing, do not go back to the store. Call Weber-Stephen Products Customer Service Center toll free **1-800-446-1071** to receive immediate assistance.

1 - Bottom unit assembly

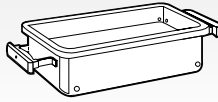

1 - Lid assembly

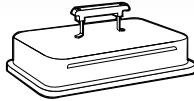

1 - Cooking grate



1 - Flavorizer Bar



1 - Burner tube

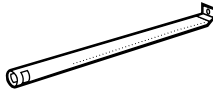

1 - Regulator assembly



1 - Retaining clip (on regulator)



2 - Legs

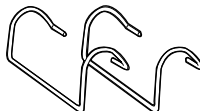

**1 - Leg Lock**



**1 - 1/4-20 wing nut**



**1 - 5/16" Washer**



**1 - 1/4-20 x 1/2 bolt**

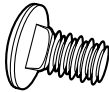

**2 - 10-24 screws**

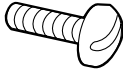

**2 - 10-24 wing nuts**



**6 - 1/4" Flat washers**



**1 - Igniter**

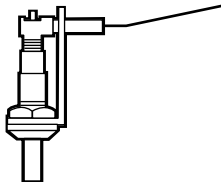

## Install Legs

Place washers on leg ends and insert ends into holes in bottom unit. Be careful not to scratch the porcelain finish while installing the legs. Repeat with other leg.

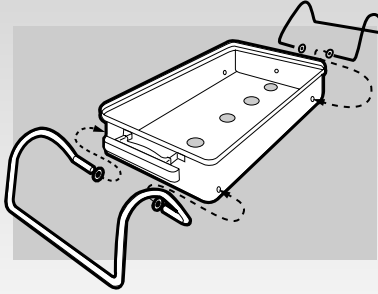

## Install Leg Lock

Position curved end of leg lock at corner of the straight portion of the leg, as shown. Push until it snaps on.

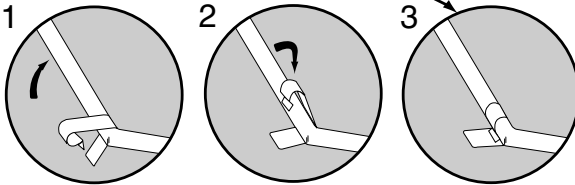
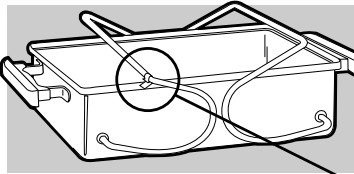

## Position legs and secure leg lock

Swing legs around so that the rounded part sets on the ground and the bottom of the cooking box rests on the straight part of the legs.

To lock the legs in place turn the leg lock around clipping it over the opposite leg. (Unlock the legs by unlatching this clip in the reverse direction.)

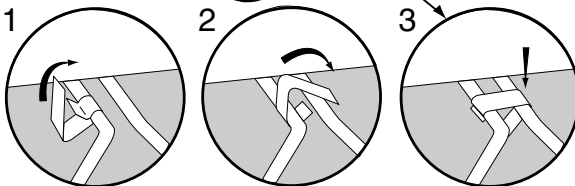
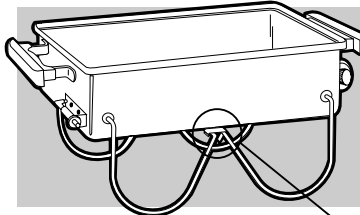

## Install Burner Tube

From the inside, insert burner tube through the large hole in the side of the bottom unit. Line up the other end of the tube with the hole. Insert the 1/2 inch bolt. Add the washer and wing nut. Tighten.

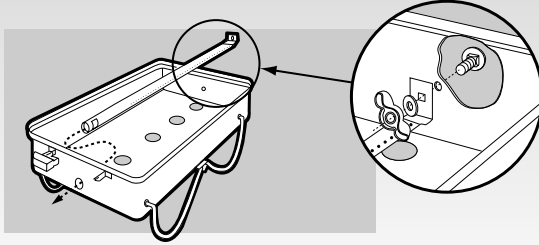

## Install Regulator

Remove the retaining clip from the regulator. Attach regulator assembly by inserting the brass fitting into the end of the burner tube. Secure regulator assembly by installing the retaining clip in the square openings on both sides of the burner tube.

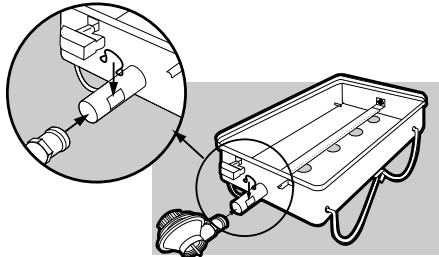

## Install Igniter

Insert the igniter electrode and two 10-24 screws through the igniter bracket and the holes in the bottom unit on the side opposite the regulator.

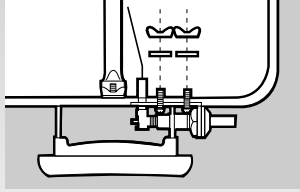

Add washers and wing nuts, making sure that the wing nuts are secured in a vertical position.

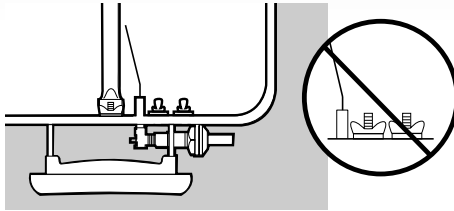

The igniter electrode has been pre-bent. It may need to be adjusted so the tip is approximately 1/8 inch from the holes in the burner tube.

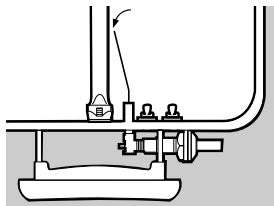

### **⚠ DANGER**

**Make sure the tip of the igniter wire is adjusted to the holes in the burner tube. If it is not adjusted properly, gas can accumulate in the barbecue while igniting the barbecue. Delayed ignition of the accumulated gas may occur. This will result in a fire or explosion which can cause serious bodily injury or death, and damage to property.**

## Install Flavorizer Bar

Place the Flavorizer Bar in bottom unit, covering the burner.

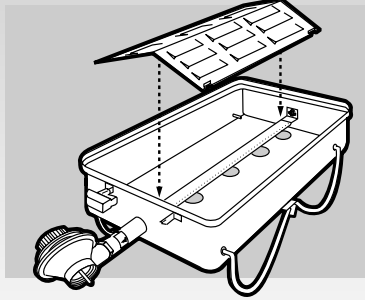

## Install Cooking Grate

Set the cooking grate onto the recessed edge of the bottom unit.

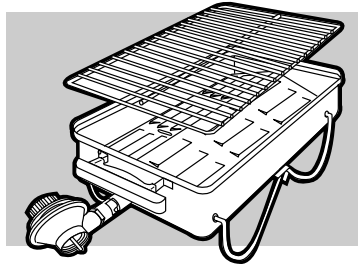

## To Secure for Transport

Put the lid on the bottom unit unlock legs and pivot them into the locked position up over the projections on the lid.

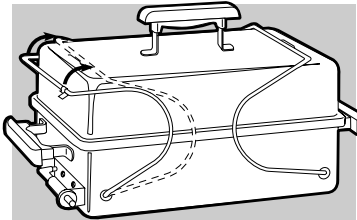

## To Use

Pivot legs under grill and lock legs. The hooks on the inside of the lid allow it to rest on the edge of the bottom unit.

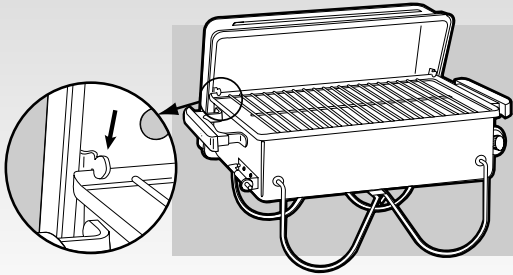

**Read important DANGERS, WARNINGS and CAUTIONS in Owner's Guide before operating this barbecue.**

## Connecting the Cylinder

1. Lubricate the threads of the regulator assembly with petroleum jelly.
2. Make sure the burner control valve is in the LOCK/OFF position before attaching the propane cylinder. Valve closes by turning the knob clockwise to the LOCK/OFF position.
3. Attach the propane cylinder to the grill by pushing the cylinder slightly while turning clockwise into the regulator. Turn until a snug fit is obtained.



# Check for Gas Leaks

---

## **⚠ DANGER**

**Do not use an open flame to check for gas leaks. Be sure there are no sparks or open flames in the area while you check for leaks. This will result in a fire or explosion which can cause serious bodily injury or death, and damage to property.**

1. Check the connection between the tank and the regulator for gas leaks. Mix a couple of tablespoons of liquid detergent with an equal amount of water.
2. Be sure to leave the burner control valve in the LOCK/OFF position. Wet the connection with the soap solution and watch for bubbles. If bubbles form or if a bubble grows, there is a leak.
3. If there is a leak, check the fitting, make sure it is tight, recheck the connections.
4. Check for gas leaks each time you disconnect or connect the gas supply.

# Lighting Your Gas Grill

---

**⚠ WARNING: Always remove the lid before lighting your grill.**

1. Push down the burner control valve and turn counter-clockwise to HIGH.
2. Hold the handle of the bottom unit while pushing the igniter button 2 or 3 times.

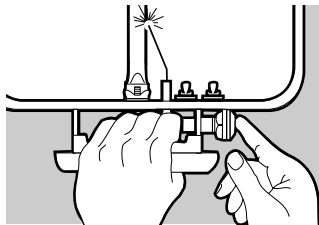

3. Check to see if the burner is lit by looking through the viewing hole in the Flavorizer Bar.

**⚠ WARNING: If burner does not light, turn burner control valve OFF, wait 5 minutes for the gas to clear, then try again.**

# Manual Lighting

---

1. Light a match and hold it in one of the four holes in the bottom of the grill.
2. Push down burner control valve and turn counter-clockwise to HIGH.
3. Check to see if the burner is lit by looking through the viewing hole in the Flavorizer Bar.

**⚠WARNING: If burner does not light, turn burner control valve OFF, wait 5 minutes for the gas to clear, then try again.**

# Gas Grill Care

---

While lid is warm, wipe inside with paper towels to prevent grease build-up.

After cooking, burn grease residues off by turning burner control valve to HIGH for several minutes with the lid in place.

It is not necessary to wash cooking grate after each use. Simply loosen residue with a brass bristle brush or crumpled aluminum foil. Then wipe with paper towels.

Thoroughly clean your gas grill at least once a year.

1. Remove cooking grate and Flavorizer Bar.
2. Remove tubular burner before cleaning (refer to assembly instructions)  
To remove: Take out retaining clip and remove regulator assembly. Remove wing nut, washer and bolt (on opposite end inside unit). Lift tubular burner up and slide out of grill.
3. Wipe out with paper towels and wash with a mild detergent and water. Rinse well. Wash Flavorizer Bar and cooking grate with warm soapy water. Rinse, then wipe dry with a paper towel.
4. Reinstall tubular burner, Flavorizer Bar, and cooking grate.
5. Check for gas leaks before operating.

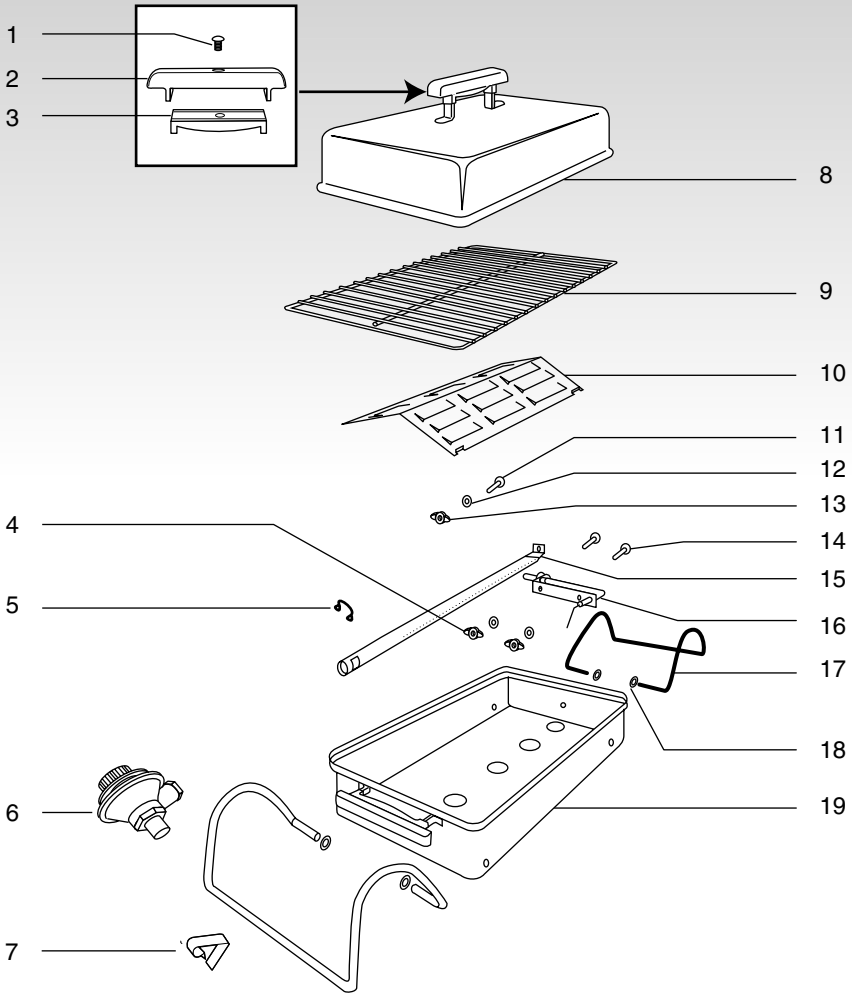

- 1-3. Handle
- 4. 10-24 Wing Nuts
- 5. Retaining Clip
- 6. Regulator Assembly
- 7. Leg Lock
- 8. Lid
- 9. Cooking Grate
- 10. Flavorizer Bar
- 11. Bolt

- 12. 5/16" Flat Washer
- 13. 1/4-20 Wing Nut
- 14. Machine Screw
- 15. Burner Tube
- 16. Igniter
- 17. Legs
- 18. Flat Washer
- 19. Bottom unit

